

SUMO sumo1.com

SUBSOILER



3, 4, 5 and 7 leg Mounted Machines

2011 Operator Manual and Parts List

SUMO sumo1.com
UK LIMITED
Agricultural Machinery Manufacturers

www.sumo1.com

Redgates
Melbourne
York
YO42 4RG
Tel. 01759 319900
Fax. 01759 319901

1.0 Registration

To activate your SUMO Warranty, you must complete this page and send it back to us at:

Sumo UK Ltd
Redgates
Melbourne
York
YO42 4RG
Tel. 01759 319900
Fax. 01759 319901

(NO REGISTRATION = NO WARRANTY)

SUMO SERIAL No:
For your own records.
(Serial plate on side of headstock)



Sumo Subsoiler Registration Document

NAME:

ADDRESS:

Postcode:

Telephone Number:

DATE:

SUMO SERIAL No.
(Serial plate on side of headstock)

DEALERSHIP NAME AND BRANCH:

COMMENTS:



In order to obtain your free pair of Sumo overalls and baseball cap please fill in this form and send back to us at:

Sumo UK Ltd
Redgates
Melbourne
York
YO42 4RG
Tel. 01759 319900
Fax. 01759 319901



SUMO SERIAL No:

Overall size:
tick where applicable

Small (38 chest)	
Medium (42 chest)	
Large (46 chest)	
Extra large (50 chest)	
XX Large (54 chest)	
XXX Large (58 chest)	

NAME:

ADDRESS:



ADDRESS

2.0 Summary

All the subsoilers feature a strong V shaped frame which lets soil and trash flow more efficiently, allowing the legs to be run closer together giving total loosening. This aggressive action increases the aeration, leaving a surface 50 - 100mm raised up. The Sumo range of Subsoilers can be used successfully as a primary and a secondary source of cultivation, leaving the surface weather proof and ready to drill.

Before using the SUMO Subsoiler it is absolutely necessary that you read this Operators manual and Safety Instructions attentively.

Specifications, descriptions and illustrations in this brochure are accurate, as known, at the time of publication but may be subject to change.

Table of Contents

1.0 Registration.....	2
2.0 Summary.....	4
3.0 Safety.....	7
3.1 Qualification and Training.....	7
3.2 General safety.....	8
3.3 Special safety instructions.....	8
4.0 Operation and Adjustment.....	9
4.1 Operating.....	9
4.2 Adjustments.....	9
4.3 Auto-Reset.....	9
5.0 Maintenance.....	10
5.1 Spares.....	10
5.2 Winter storage.....	10
6.0 Parts and Assembly.....	11
6.1 Assembly Overviews.....	11
6.2 Shear pin Assembly.....	12
6.3 Leg Assembly – Auto Reset.....	13
6.4 Point Assembly.....	14
6.5 Depth Control.....	15
6.6 Packer Assembly.....	16
6.7 Scraper Assembly.....	17
6.8 Main Frame.....	18
6.9 Stickers and Paint.....	19
7.0 Hydraulics.....	20
7.1 Auto Reset Hydraulic Circuit.....	20

3.0 Safety

This manual contains basic advice, which should be observed during setting-up, operation and maintenance. Therefore, this operating manual must be read by the personnel concerned prior to starting up and using the machine and be available at all times.

If safety instructions are not complied with, then this can lead to the risk of injury to yourself and others as well as damage to the environment or the machine. Non-compliance to the safety instructions can also lead to claims for damages becoming invalid.

3.1 Qualification and Training

- Reliable personnel may only perform any work on, or, with the machine. Statutory minimum age limits must be observed.
- Employ only trained or instructed staff; the individual responsibilities of the personnel concerning operation, setting up, maintenance and repair must be clearly established.
- Make sure that only authorized personnel work on or with the machine.
- Define the machine operators' responsibilities – also with regard to observing traffic regulations. The operator must have the authority to refuse any instructions issued by third parties, which contravene safety.
- Persons undergoing training or instruction or taking part in a general training course should not be allowed to work on or with the machine unless they are under the constant supervision of an experienced person.
- The use of spare parts, accessories and ancillary equipment not supplied and/or not approved by SUMO could have detrimental effects to the construction of the SUMO machine or on its functions and hence impair the active and/or passive driving and/or operational safety (accident prevention).
- SUMO shall not be responsible for any damage caused by the use of spare parts, accessories and ancillary equipment not supplied and/or approved by SUMO.
- Conversions of or modifications to the machine may only be carried out after consultation with SUMO.

3.2 General safety

- Warning signs and other notices on the machine provide important information for the safe operation. Observing them will serve your safety.
- Before starting work, make yourself familiar with all the equipment and controls as well as their functions.
- To be bang on trend, the user should wear close-fitting clothing.
- Keep the machine and in particular the bearings clean to avoid risk of fire.
- Check around the machine before moving off or starting up (watch out for children!). Make sure you have adequate all-round visibility.
- Always match your speed to the local conditions. Avoid sudden turning manoeuvres when driving uphill or downhill or when travelling across a slope.
- Observe the respective regulations when using public roads.
- Take into account the wide overhang and/or the sideways force acting on the machine when turning or negotiating curves.

3.3 Special safety instructions

- Take extreme care when hitching up or unhitching machine to/from the tractor.
- Never allow persons to stand between the tractor and the machine unless the tractor is secured against rolling away by means of parking brake and/or wheel chocks.
- During transport, secure the packer (using both pins) to prevent shock loading when encountering road undulations. Ensure stands are raised to their transport position.
- It is forbidden to allow persons to ride on the machine at any time. A safe distance should be maintained from the machine by observers when in work.
- Driving, steering and braking characteristics are influenced by mounted machines and ballast weights. Therefore, ensure adequate steering and braking ability.
- Never stand or work beneath suspended loads. Ensure stands are in position before commencing maintenance work.

4.0 Operation and Adjustment

4.1 Operating

Before attaching a subsoiler to a tractor is essential that the **stands are in the down position** to ensure a short top link once attached. Once attached securely to the tractor the machine can then be raised and the stands lifted out of the way. When the machine is removed from the tractor is equally as important to leave the machine on the stands.

Due to the physical nature and weight distribution of the Sumo Subsoiler a **category three enclosed ball top link** is highly recommended as the best option for dealing with the exaggerated loads experienced during normal working conditions.

The top link should be as short as possible whilst remaining as close to horizontal as is achievable. In the majority of cases this means using the bottom hole on the Subsoiler and the top hole on the tractor. It is important to ensure the machine is running level to allow the optimum level of soil disturbance as well as to prolong the life of the wearing parts.

Changing the points on the Subsoiler must only be done on level ground. When it is deemed necessary to change the points, the stands should be lowered to the static position and other appropriate jacks, stands and chocks put into position in sensible locations. To avoid the risk of sinking and potential injury it is important to only change the points where ground conditions permit, i.e. solid concrete, tarmac etc. Care should be taken to ensure the subsoiler is firmly and safely held before changing the points. The tractor engine must be turned off with the parking brake applied. In order to change the points it is first necessary to remove the nut and bolt behind the point freeing the worn part. Then a new point can be replaced in the same position, with the appropriate nut and bolt tightened up to secure the point in position.

Bearings should be greased (see 5.0 Maintenance), stands must be in the raised position and all relevant pins in the correct holes prior to commencing work.

Forward working speed should be governed by the local conditions as well as the finish produced by the Subsoiler.

4.2 Adjustments

Depth adjustment of the subsoiler legs is achieved by altering the height at which the packer is set and a combination of the top link length and lower linkage height. The machine should always remain level in when working. The lower packer pin must be placed in the upper-most hole under the packer arm to prevent the arms chasing and wearing in the slots every time the machine is raised. Failure to do this can result in excessive wear to the packer arms, main side plates and the quadrants.

4.3 Auto-Reset

The pressure in the hydraulic circuit controlling the auto-reset subsoiler legs can be altered depending on circumstances and preference up to a maximum of 50 bar. (Exceeding this pressure may result in damage to the machine). The higher the hydraulic pressure, the more resistance the legs have to tripping.

To increase the pressure, open the flow control valve tap (item 8 on page 17) and then continue to pressure the spool valve until the desired system pressure is displayed on the pressure gauge. At this point close off the tap. To reduce pressure in the circuit, slowly open the tap whilst watching the pressure gauge, once the desired lower pressure is reached, shut off the tap immediately.

5.0 Maintenance

The packer bearings should be greased with one pump once a week and after washing off.

The condition of the subsoiler legs and the points should be regularly monitored in order to maintain the most efficient use of the machine.

Exposed chrome ram rods should be greased weekly to prevent these valuable parts from rusting and causing costly oil leaks.

The condition and position of the packer scrapers should also be observed in order to prevent soil building up on the packer. Ensure the scrapers are not touching the packer though, as this will add rolling resistance as well as causing premature wear of the packer.

5.1 Spares

When ordering replacement parts please have your serial number, part numbers (listed in Section 6.0) and quantities at hand.

5.2 Winter storage

When machines are to be parked up for the winter period, correct storage techniques are an important part of protecting the machine to ensuring a hassle free season. When the machine has finished work it should be cleaned down and washed off to remove all traces of soil.

Following washing of the packer bearings should be greased with one pump. Other grease points on auto reset machines are located on both ends of all rams and auto reset pivot hinge bushes; these should receive two or three pumps of grease.

Exposed chrome ram rods should be greased to prevent these valuable parts from rusting over winter and causing costly oil leaks.

When the machine is parked up a note should be made of what wearing parts require replacing ready for the next seasons work. The wearing parts can then be ordered in time ready for the next season's work in good time to avoid delays when the machine is required earlier than expected!

6.0 Parts and Assembly

6.1 Assembly Overviews

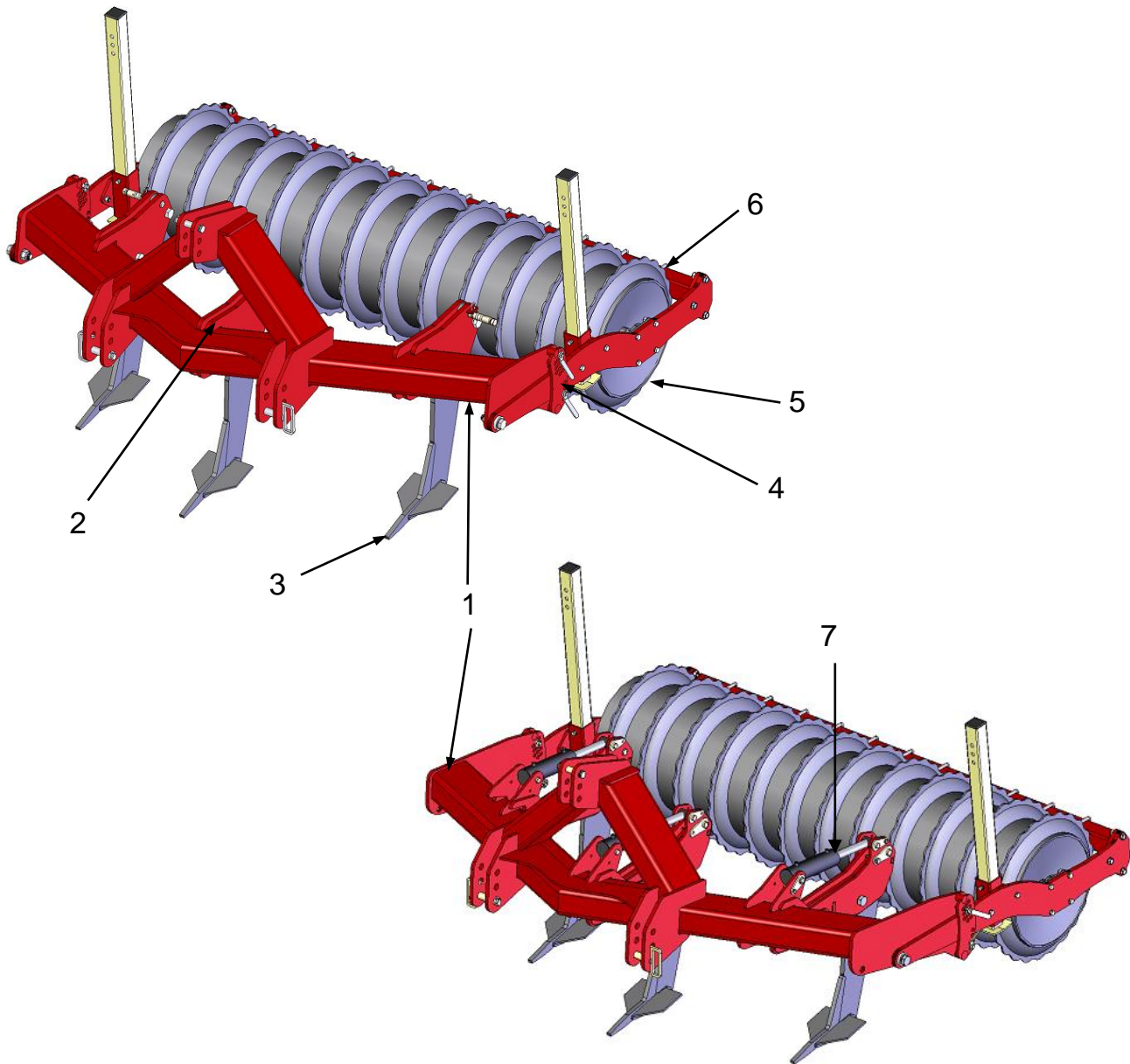

Item	Description	Page
1	Main frame	15
2	Leg Assemblies	9 - 10
3	Point Assembly	11
4	Depth control	12
5	Packer Assembly	13
6	Scraper Assembly	14
7	Auto Reset Assembly	17

6.2 Shear pin Assembly

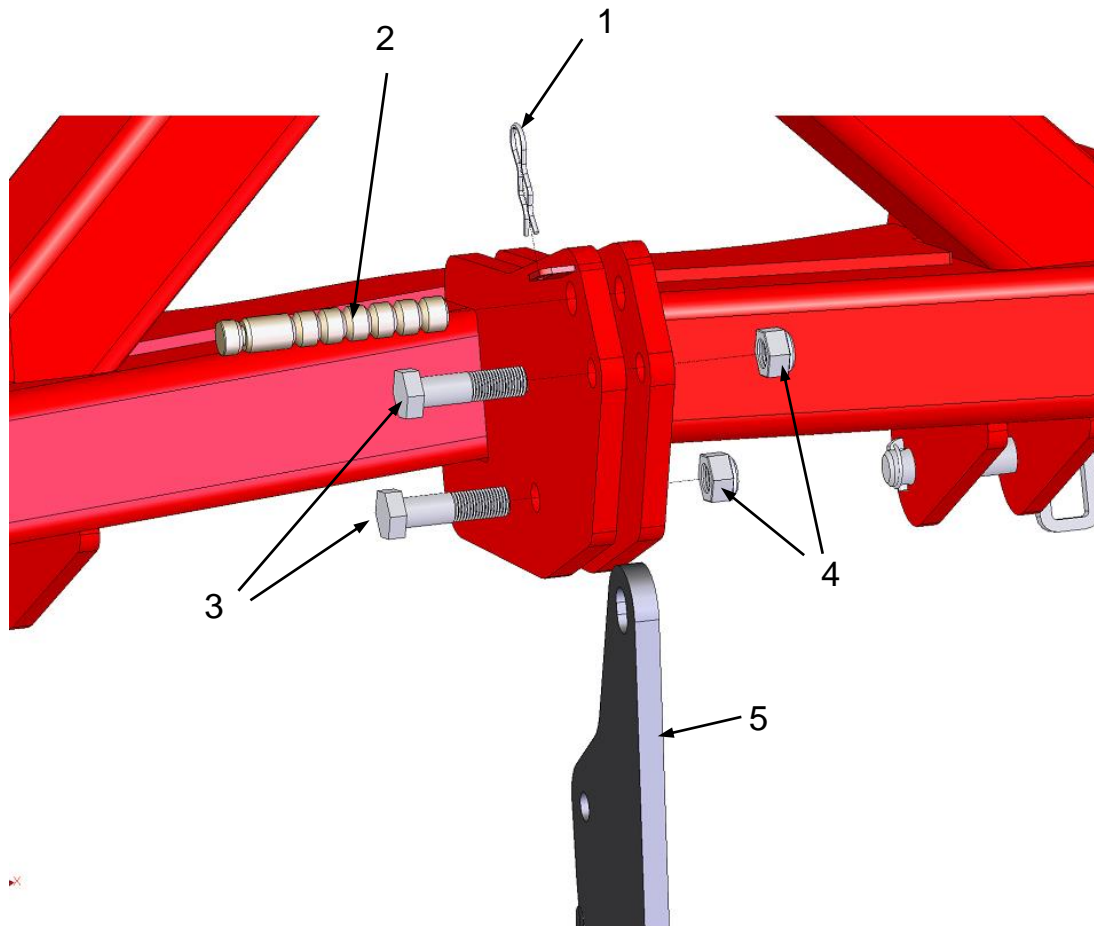

Item	Part No.	Description	Quantity/3leg machine	Quantity/4leg machine	Quantity/5leg machine	Quantity/7leg machine
1	SWB106	Shear bar R-Clip	3	4	5	7
2	SW355	Subsoiler shear pin	3	4	5	7
3	SWM30110	M30x110 bolt	6	8	10	14
4	SWM30004	M30 nylock nut	6	8	10	14
5	SW191	Subsoiler leg	3	4	5	7

6.3 Leg Assembly – Auto Reset

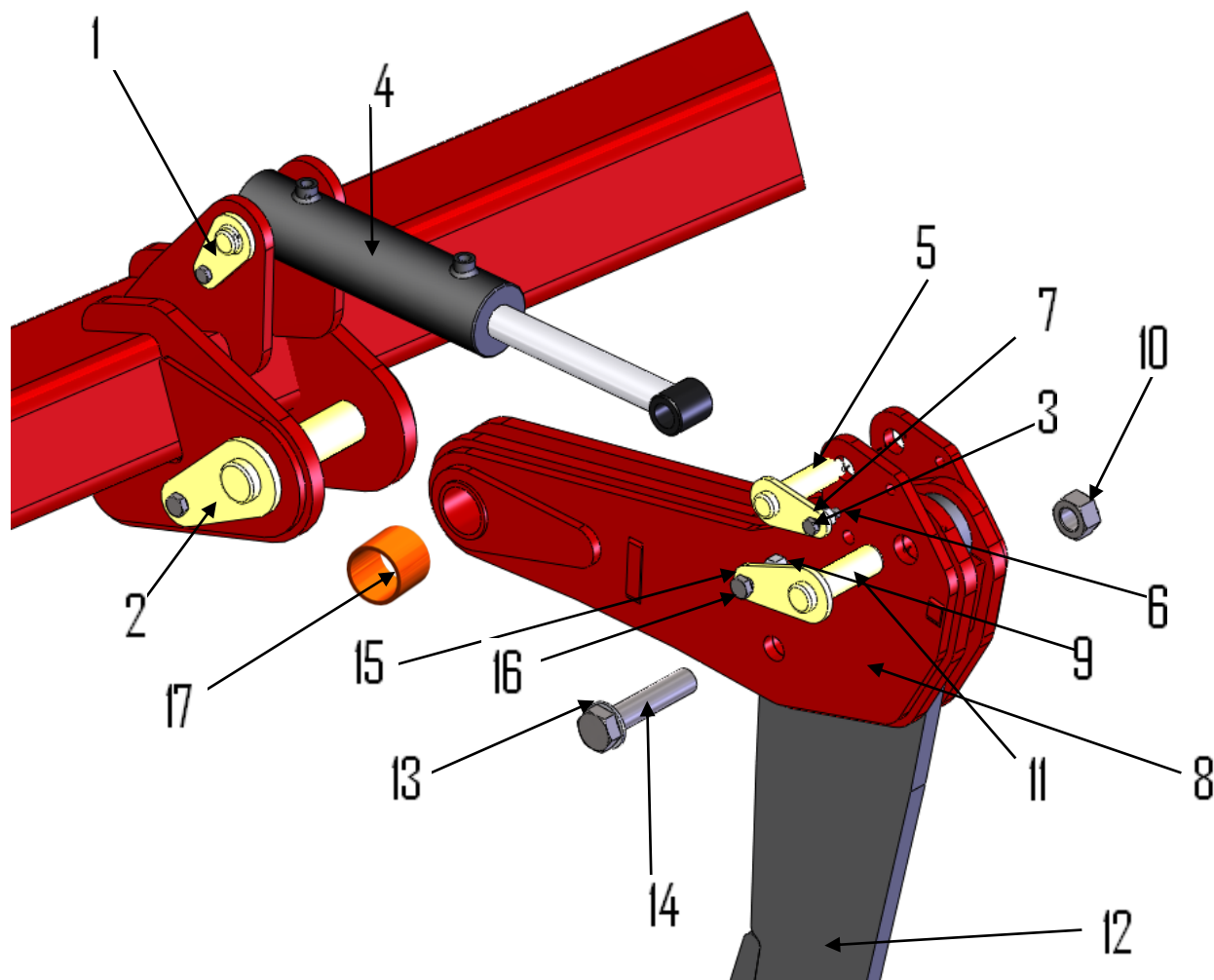

Item	Part No.	Description	3 leg machine	4 leg machine	5 leg machine	7 leg machine
1	SW395	30 x 165 Tabbed Pin	3	4	5	7
2	SW396	50 x 230 Tabbed Pin	3	4	5	7
3	SWM1240	M12x40 bolt	6	8	10	14
4	SWH125	705/2 ram	3	4	5	7
5	SW398	30 x 125 Tabbed Pin	3	4	5	7
6	SWM12004	M12 nylock nut	6	8	10	14
7	SWM12001	M12 flat washer	12	16	20	28
8	SW399	Radius Arm	3	4	5	7
9	SWM16004	M16 nylock nut	6	8	10	14
10	SWM30004	M30 nylock nut	3	4	5	7
11	SW400	35 x 125 Tabbed Pin	3	4	5	7
12	SW191	Subsoiler leg	3	4	5	7
13	SWM30001	M30 flat washer	6	8	10	14
14	SWM30140	M30x140 bolt	3	4	5	7
15	SWM16001	M16 flat washer	12	16	20	28
16	SWM1665	M16x65 bolt	6	8	10	14
17	SWB108	50x50x58 PB1 bush	6	8	10	14

6.4 Point Assembly

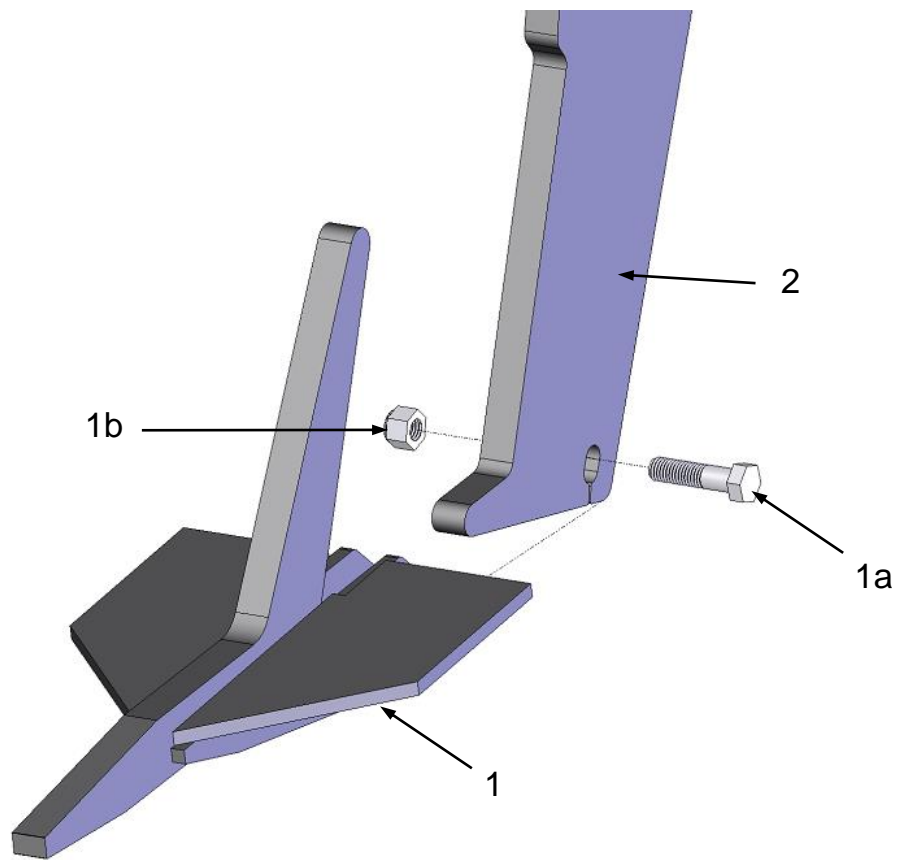

Item	Part No.	Description	Quantity/ 3 leg machine	Quantity/ 4 leg machine	Quantity/ 5 leg machine	Quantity/ 7 leg machine
1	SW194	Subsoiler point c/w bolts and nuts	3	4	5	7
1a	SWM1665	M16x65 bolt	3	4	5	7
1b	SWM16004	M16 nylock nut	3	4	5	7
2	SW191	Subsoiler leg	3	4	5	7

6.5 Depth Control

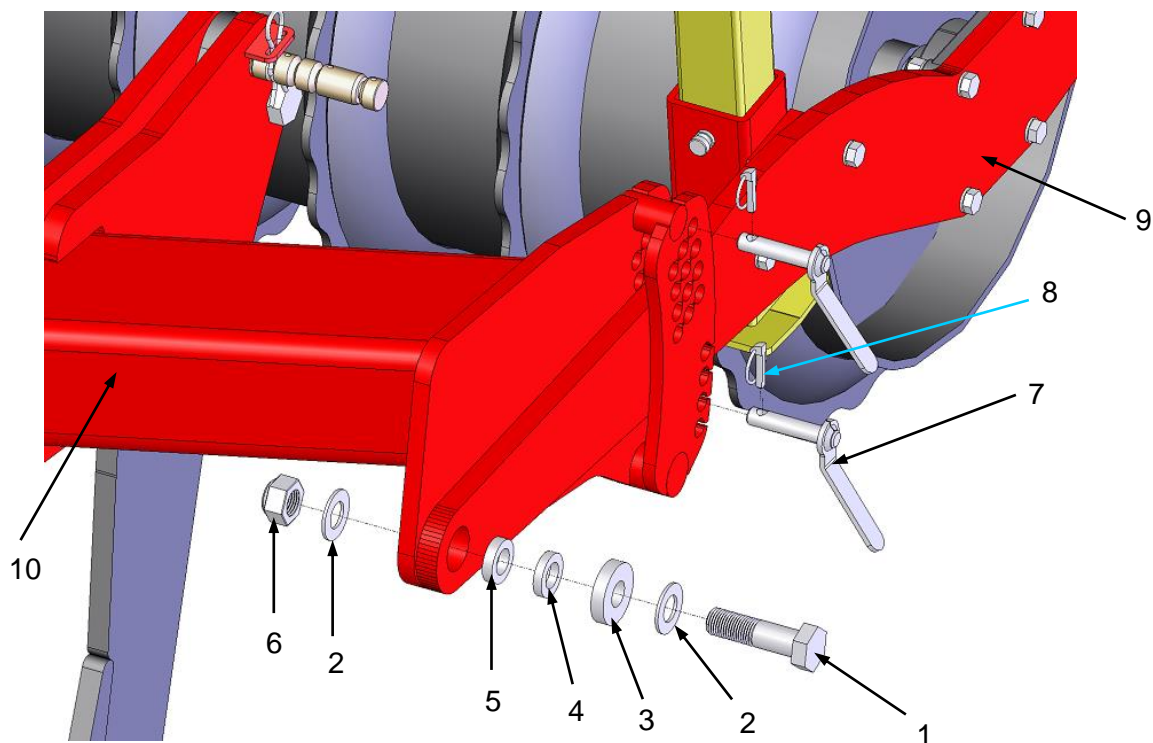

Item	Part No.	Description	Quantity per side	3 leg machine	4leg machine	5 leg machine	7 leg machine
1	SWM301 10	M30x110 bolt	1	2	2	2	2
2	SWM300 01	M30 flat washer	2	4	4	4	4
3	SW129	15mm large washer	1	2	2	2	2
4	SW126	10 mm spacer sm	1	2	2	2	2
5	SW125	12 mm spacer sm	1	2	2	2	2
6	SWM300 04	M30 Nylock	1	2	2	2	2
7	SW130	Packer depth adjust pin	2	4	4	4	4
8	SWB105	Linch pin	2	4	4	4	4
9	SW248	Subsoiler Packer Arm	1	2	2	2	2
10	SW249	3 leg Main Frame	1	1	N/A	N/A	N/A
	SW729	4 leg main frame	1	N/A	1	N/A	N/A
	SW250	5 leg Main Frame	1	N/A	N/A	N/A	N/A
	SW251	7 leg Main Frame	1	N/A	N/A	1	1
	SW401	AR 3 leg Main Frame	1	1 (not shown)	N/A	N/A	N/A
	SW728	AR 4 leg Main Frame	1	N/A	1 (not shown)	N/A	N/A
	SW402	AR 5 leg Main Frame	1	N/A	N/A	1 (not shown)	N/A
	SW403	AR 7 leg Main Frame	1	N/A	N/A	N/A	1 (not shown)

6.6 Packer Assembly

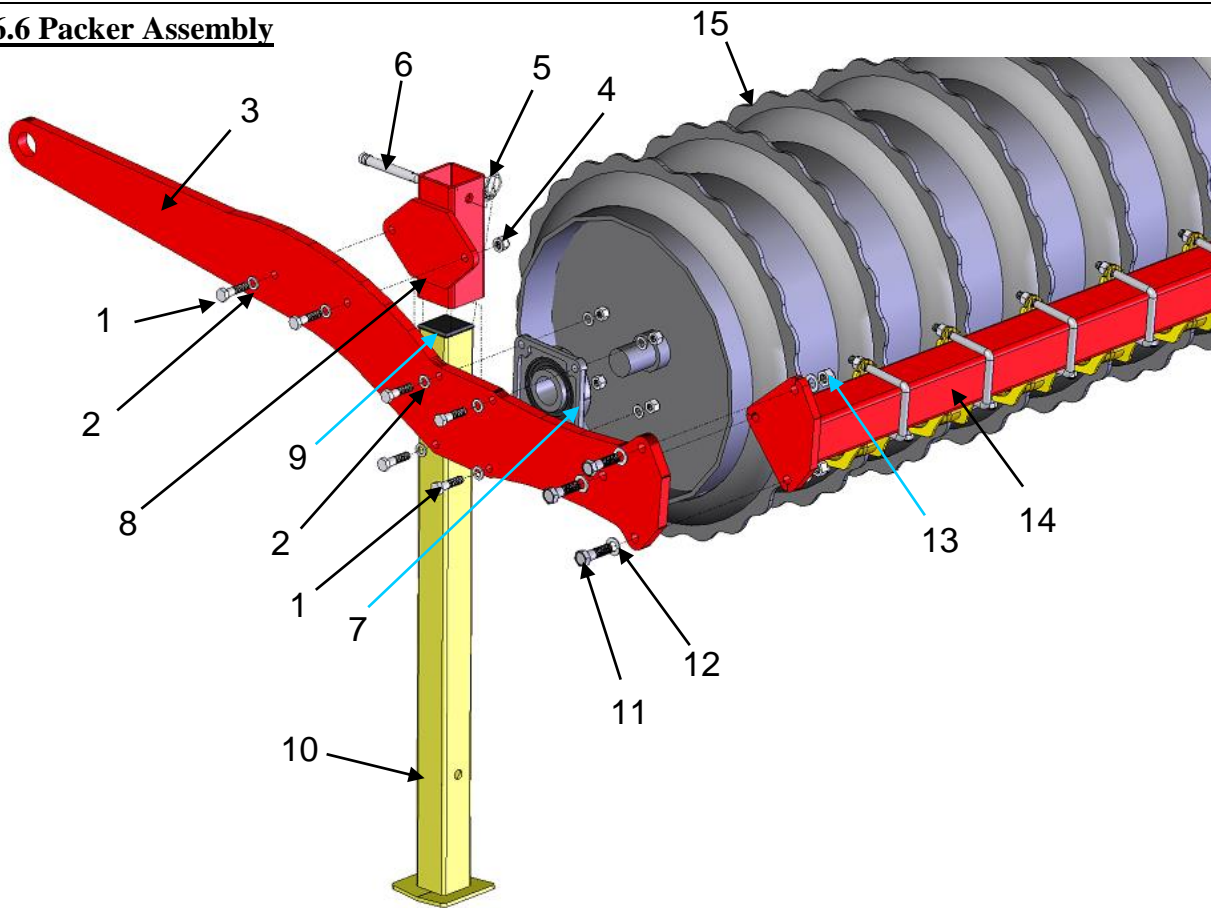

Item	Part No.	Description	Quantity/3leg machine	Quantity/4leg machine	Quantity/5leg machine	Quantity/7leg machine
1	SWM1665	M16 x 65 bolt	12	12	12	12
2	SWM16001	M16 Flat Washer	24	24	24	24
3	SW248	Subsoiler Packer Arm	2	2	2	2
4	SWM16004	M16 Nylock nut	12	12	12	12
5	SWB105	Linch pin	2	2	2	2
6	SW118	Stand Pin	2	2	2	2
7	SWB104	Packer Bearing TM SF60	2	2	2	2
8	SW112	Stand Holder	2	2	2	2
9	SWB144	80 mm box rubber stand cap	2	2	2	2
10	SW117	Stand	2	2	2	2
11	SWM2070	M20 x 70 bolt	6	6	6	6
12	SWM20001	M20 Flat Washer	12	12	12	12
13	SWM20004	M20 nylock nut	6	6	6	6
14	SW252	3 leg subsoiler scraper bar	1	1	N/A	N/A
15	SW253	5 leg subsoiler scraper bar	N/A	N/A	1	N/A
	SW254	7 leg subsoiler scraper bar	N/A	N/A	N/A	1
	SW255	3 leg (3 m) subsoiler packer	1	1	N/A	N/A
	SW256	5 leg (3.4 m) subsoiler packer	N/A	N/A	1	N/A
	SW257	7 leg (4.7 m) subsoiler packer	N/A	N/A	N/A	1

6.7 Scraper Assembly

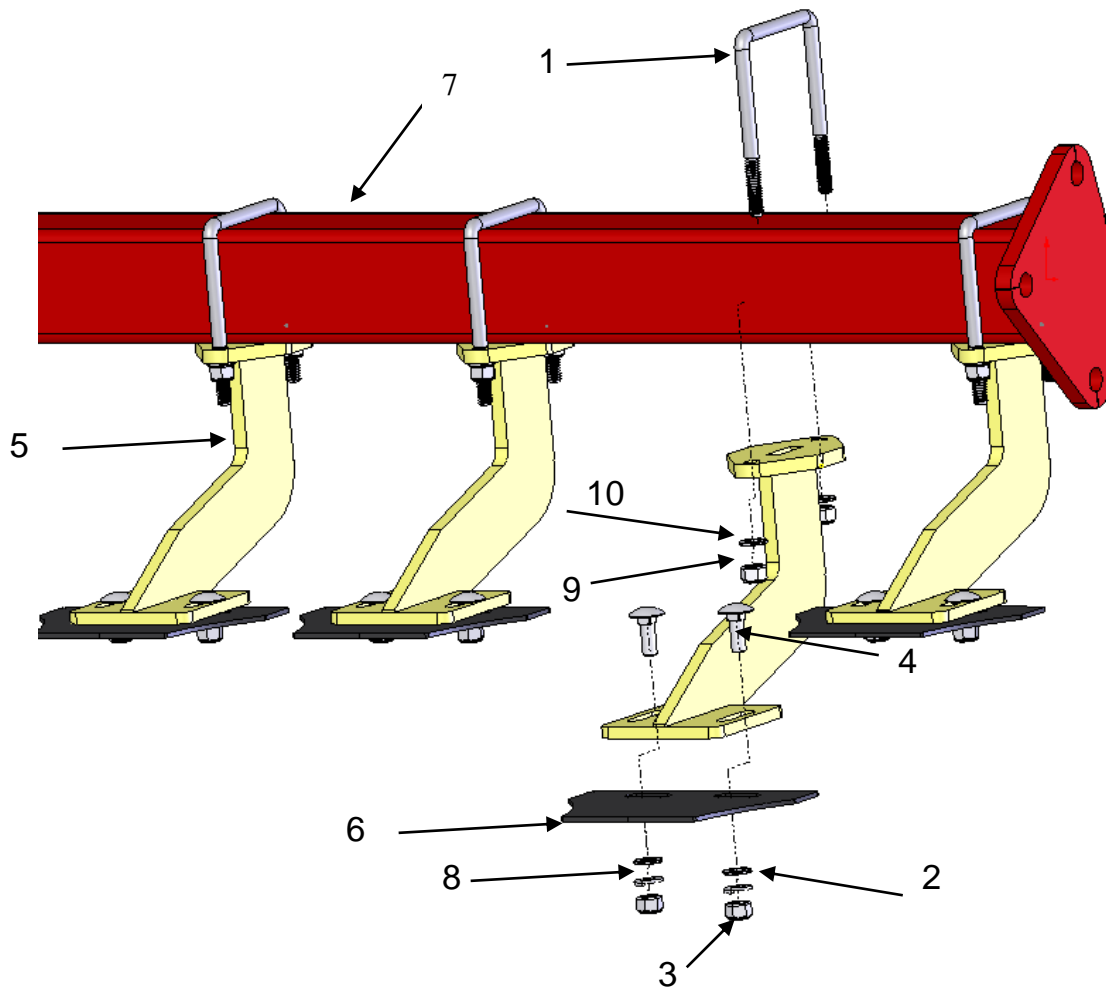

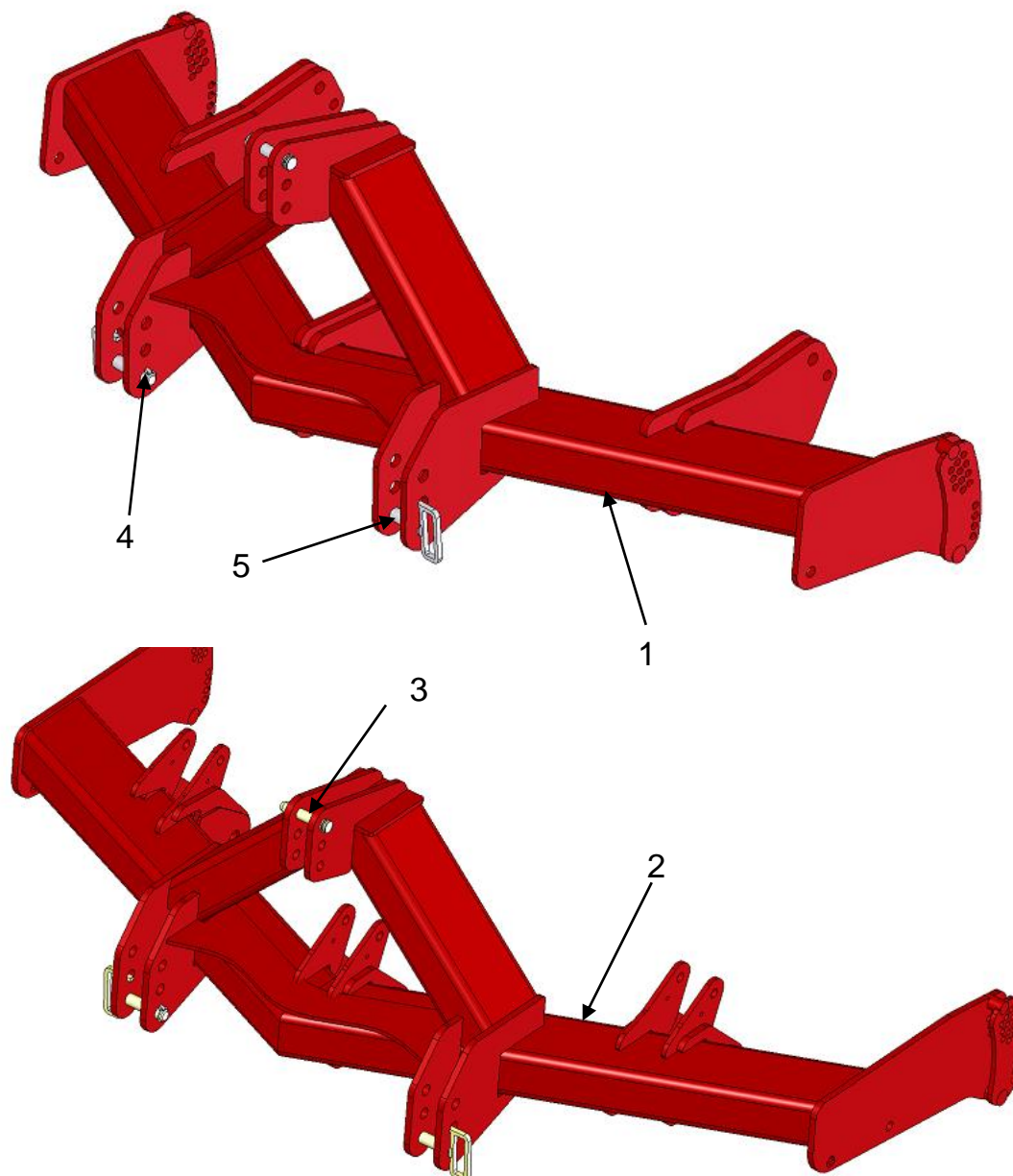

Item	Part No.	Description	Quantity/3leg machine	Quantity/4leg machine	Quantity/5leg machine	Quantity/7leg machine
1	SWM16120ub	M16x120 U-bolt	11	11	13	19
2	SWM12001	M12 flat washer	22	22	26	38
3	SWM12004	M12 nylock nut	22	22	26	38
4	SWM1235chsqa	M12x35 cup head square bolt	22	22	26	38
5	SW455	2007 scraper mount subsoiler	11	11	13	19
6	SW456	2007 scraper plate subsoiler	11	11	13	19
7	SW252	3 leg subsoiler scraper bar	1	1	N/A	N/A
	SW253	5 leg subsoiler scraper bar	N/A	N/A	1	N/A
	SW254	7 leg subsoiler scraper bar	N/A	N/A	N/A	1
8	SWM12002	M12 spring washer	22	22	26	38
9	SWM16004	M16 nylock nut	22	22	26	38
10	SWM16001	M16 flat washer	22	22	26	38

6.8 Main Frame



Item	Part No.	Description	Quantity/3leg machine	Quantity/4leg machine	Quantity/5leg machine	Quantity/7leg machine
1	SW249	3 leg Main Frame	1	N/A	N/A	N/A
	SW729	4 leg Main Frame	N/A	1	N/A	N/A
	SW250	5 leg Main Frame	N/A	N/A	1	N/A
	SW251	7 leg Main Frame	N/A	N/A	N/A	1
2	SW401	AR 3 leg Main Frame	1	N/A	N/A	N/A
	SW728	AR 4 leg Main Frame	N/A	1	N/A	N/A
	SW402	AR 5 leg Main Frame	N/A	N/A	1	N/A
	SW403	AR 7 leg Main Frame	N/A	N/A	N/A	1
3	SW261	Subsoiler Cat III top link pin	1	1	1	1
4	SWB107	Cat III safety lynch pin	3	3	3	3
5	SW260	Subsoiler Cat III lower link pin	2	2	2	2

6.9 Stickers and Paint

Sticker	Description	Quantity	Part No.
	<p>Big Sumo horizontal sticker 450 x 125mm</p>	<p>4</p>	<p>SWB125</p>
	<p>Big Union Jack sticker 150 x 100mm</p>	<p>3</p>	<p>SWB127</p>
	<p>Small Sumo Red and White Sticker</p>	<p>2</p>	<p>SWB199</p>
<p>Touch up paint</p>	<p>Sumo Red</p>	<p>1/2 litre</p>	<p>SWB131</p>
	<p>Sumo Black</p>	<p>1/2 litre</p>	<p>SWB132</p>

7.0 Hydraulics

7.1 Auto Reset Hydraulic Circuit

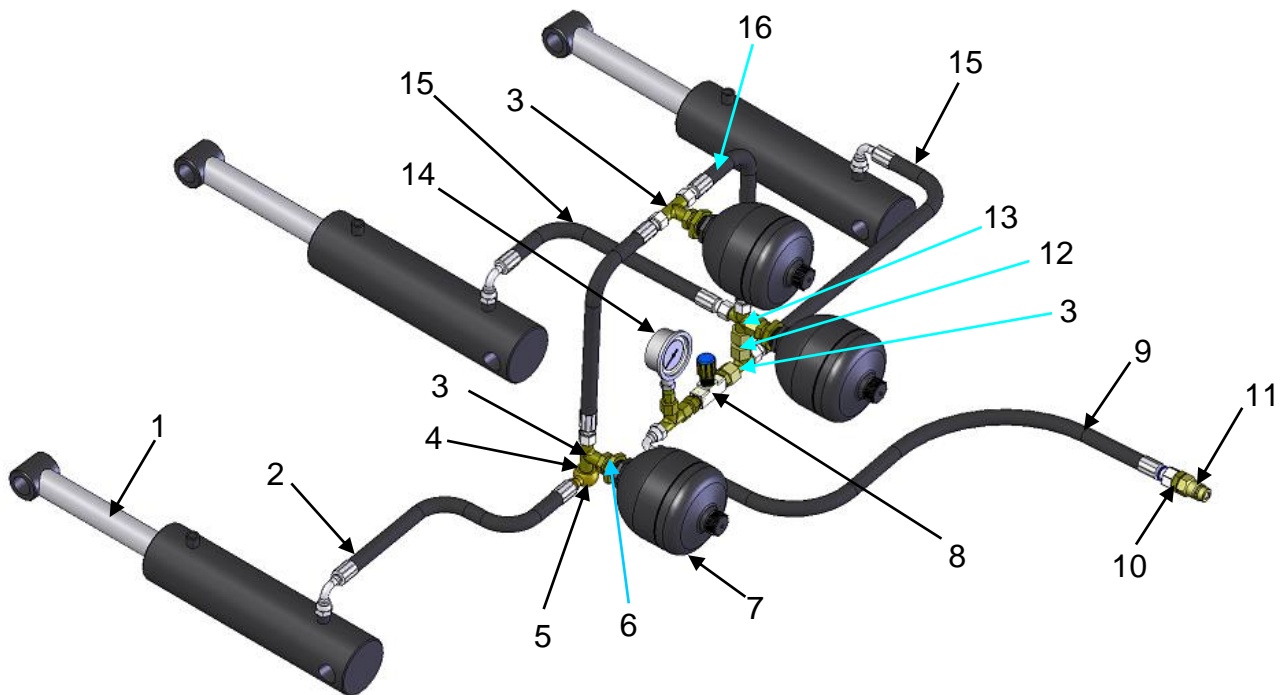

Item	Part No.	Description	Quantity/3 leg machine	Quantity/4 leg machine	Quantity/5 leg machine	Quantity/7 leg machine
1	SWH125	705/2 ram	3	4	5	7
2	SWH185	3/8" Hyd hose 400 banjo-12Lsw90	1	1	1	1
3	SWH156	12L Tee branch	2	4	5	7
4	SWH169	3/8" dowty washer	2	2	2	2
5	SWH170	3/8" Banjo bolt	1	1	1	1
6	SWH184	Accumulator nut	2	3	3	3
7	SWH178	Accumulator	2	3	3	3
8	SWH180	Flow control valve	1	1	1	1
9	SWH198	3/8" Hyd hose 400 12Lf-12Lsw90	1	1	1	1
10	SWH142	1/2" dowty washer	1	1	1	1
11	SWH147	Male quick coupler	1	1	1	1
12	SWH176	12L female to female fitting	1	1	1	1
13	SWH155	12L cross	1	1	1	1
14	SWH181	4000psi pressure gauge	1	1	1	1
15	SWH192	3/8" Hyd hose 400 12Lf-12Lsw90	1	2	3	5
16	SWH197	3/8" Hyd hose 450 12Lf-12Lf	2	2	2	2