

SUMO Rippa

4.0m, 5.0m, 6.0m and 7.0m
Folding

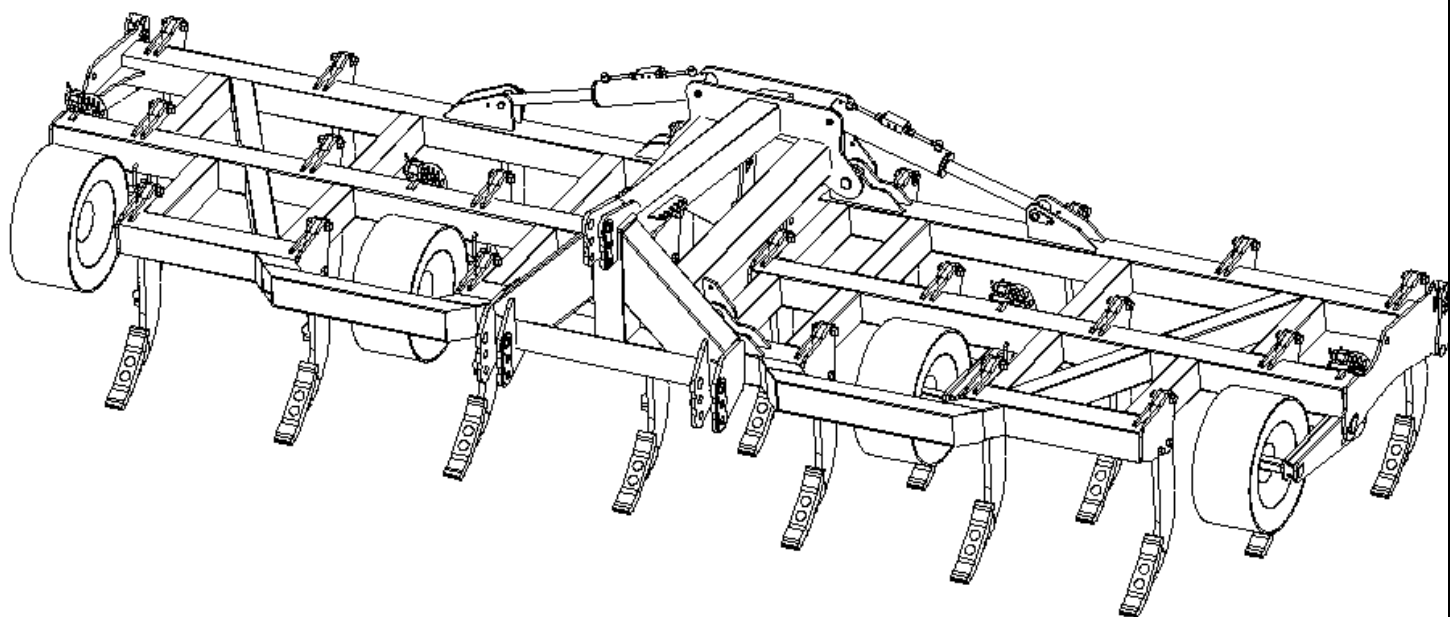

Parts list 2017
and
Operators Manual

SUMO
UK LIMITED
Agricultural Machinery Manufacturers

www.sumo1.com

Redgates
Melbourne
York
YO42 4RG
Tel. 01759 319900
Fax. 01759 319901

In order to obtain your free pair of Sumo overalls and baseball cap
please fill in this form and send back to us at:

Sumo UK Ltd
Redgates
Melbourne
York
YO42 4RG
Tel. 01759 319900
Fax. 01759 319901



SUMO SERIAL No:

Overall size:
tick where
applicable

Small (38 chest)	
Medium (42 chest)	
Large (46 chest)	
Extra large (50 chest)	
XX Large (54 chest)	
XXX Large (58 chest)	

NAME:

ADDRESS:



2.0 Summary

The Sumo Rippa is a useful tool ideally suited to the potato grower, the Sumo Rippa is used after ploughing to mix and aerate the soil ahead of bed formers or tillers. It can also be used for primary cultivation post-harvest and can work down to 14-16in to remove plough pan compaction.

Before using the SUMO Rippa it is absolutely necessary that you read this Operators manual and Safety Instructions attentively.

Specifications, descriptions and illustrations in this brochure are accurate, as known, at the time of publication but may be subject to change.

Contents

1.0 Registration	1
2.0 Summary	2
3.0 Safety	6
3.1 Qualification and Training	6
3.2 General safety	7
3.3 Special safety instructions.....	7
4.0 Operation and Adjustment	8
4.1 Operating.....	8
4.2 Adjustments	8
5.0 Maintenance	9
5.1 Spares.....	9
5.2 Winter storage.....	7
6.0 Parts and Assembly	10
6.1 Overview	10
6.2 Point Assembly	11
6.3 Leg & Shear Bolt Assembly	12
6.4 Depth Control.....	13
6.5 Wheel Assembly.....	12
6.6 Main Frame	13
6.7 Stickers and Paint.....	14
7.0 Hydraulics	
7.1 Wing open/close circuit.....	15

3.0 Safety

This manual contains basic advice, which should be observed during setting-up, operation and maintenance. Therefore, this operating manual must be read by the personnel concerned prior to starting up and using the machine and be available at all times.

If safety instructions are not complied with, then this can lead to the risk of injury to yourself and others as well as damage to the environment or the machine. Non-compliance to the safety instructions can also lead to claims for damages becoming invalid.

3.1 Qualification and Training

- Reliable personnel may only perform any work on, or, with the machine. Statutory minimum age limits must be observed.
- Employ only trained or instructed staff; the individual responsibilities of the personnel concerning operation, setting up, maintenance and repair must be clearly established.
- Make sure that only authorized personnel work on or with the machine.
- Define the machine operators' responsibilities – also with regard to observing traffic regulations. The operator must have the authority to refuse any instructions issued by third parties, which contravene safety.
- Persons undergoing training or instruction or taking part in a general training course should not be allowed to work on or with the machine unless they are under the constant supervision of an experienced person.
- The use of spare parts, accessories and ancillary equipment not supplied and/or not approved by SUMO could have detrimental effects to the construction of the SUMO machine or on its functions and hence impair the active and/or passive driving and/or operational safety (accident prevention).
- SUMO shall not be responsible for any damage caused by the use of spare parts, accessories and ancillary equipment not supplied and/or approved by SUMO.
- Conversions of or modifications to the machine may only be carried out after consultation with SUMO.

3.2 General safety

- Warning signs and other notices on the machine provide important information for the safe operation. Observing them will serve your safety.
- Before starting work, make yourself familiar with all the equipment and controls as well as their functions.
- The user should wear close-fitting clothing.
- Check around the machine before moving off or starting up (watch out for children!). Make sure you have adequate all-round visibility.
- Always match your speed to the local conditions. Avoid sudden turning manoeuvres when driving uphill or downhill or when travelling across a slope.
- Observe the respective regulations when using public roads.
- Take into account the wide overhang and/or the sideways force acting on the machine when turning or negotiating curves.
- Ensure that the wings are locked in the upright position when moving down the road by moving the taps to the off position.

3.3 Special safety instructions

- Take extreme care when hitching up or unhitching machine to/from the tractor.
- Never allow persons to stand between the tractor and the machine unless the tractor is secured against rolling away by means of parking brake and/or wheel chocks.
- It is forbidden to allow persons to ride on the machine at any time. A safe distance should be maintained from the machine by observers when in work.
- Driving, steering and braking characteristics are influenced by mounted machines and ballast weights. Therefore, ensure adequate steering and braking ability.
- Never stand or work beneath suspended loads.

4.0 Operation and Adjustment

4.1 Operating

Due to the physical nature of the Sumo Rippa **a category three enclosed ball top link is highly recommended** as the best option for dealing with the exaggerated loads experienced during normal working conditions.

The top link should be as short as possible whilst remaining as close to horizontal as is achievable. In the majority of cases this means using the bottom hole on the Rippa and the top hole on the tractor. It is important to ensure the machine is running level to allow the optimum level of soil disturbance as well as to prolong the life of the wearing parts.

The Rippa is fitted with reversible points and once worn can be flipped over. In order to flip over or change the points first the Rippa must be secured as not to cause any harm to the operator when working on the machine. Also the tractor engine must be turned off with the parking brake applied. In order to change the points it is first necessary to remove the two nuts and bolts behind the leg freeing the worn part. Then the point can be either be flipped over or replaced with a new point in the same position, with the appropriate nut and bolt tightened up to secure the point in position. The Rippa tines are protected with a shear bolt located through the leg and in the event of one breaking it needs to be replaced with the appropriated nut and bolt (see 6.3 Leg & Shear bolt Assembly).

Forward working speed should be governed by the local conditions.

4.2 Adjustments

Depth adjustment of the Rippa is achieved by altering the height at which the pair of pneumatic depth wheels are set by using a unique pin system (see 6.4 Depth Control page 11). This and a combination of the top link length and lower linkage height help to change the depth of the machine. Always ensure the machine is working level to achieve uniform results.

5.0 Maintenance

The condition of the Rippa legs and the points should be regularly monitored in order to maintain the most efficient use of the machine.

Exposed chrome ram rods should be greased weekly prevent these valuable parts from rusting and causing costly oil leaks.

Wheel nuts should be regularly checked and tightened if necessary.

Greasing points are located at the wing pivots. Depth wheel pivots and at each end of every ram. They should receive 2 to 3 pumps of grease every week.

5.1 Spares

When ordering replacement parts please have your serial number, part numbers (listed in Section 6.0) and quantities at hand.

5.2 Winter storage

When machines are to be parked up for the winter period, correct storage techniques are an important part of protecting the machine to ensuring a hassle free season. When the machine has finished work it should be cleaned down and washed off to remove all traces of soil.

Following washing of the packer bearings should be greased with one pump if fitted. Other grease points are located on both ends of all rams, wing hinge bushes, and these should receive two or three pumps of grease.

Wheel studs should be checked that they are tight.

Exposed chrome ram rods should be greased to prevent these valuable parts from rusting over winter and causing costly oil leaks.

When the machine is parked up a note should be made of what wearing parts require replacing ready for the next seasons work. The wearing parts can then be ordered in time ready for the next season's work in good time to avoid delays when the machine is required earlier than expected!

6.0 Parts and Assembly

6.1 Overview

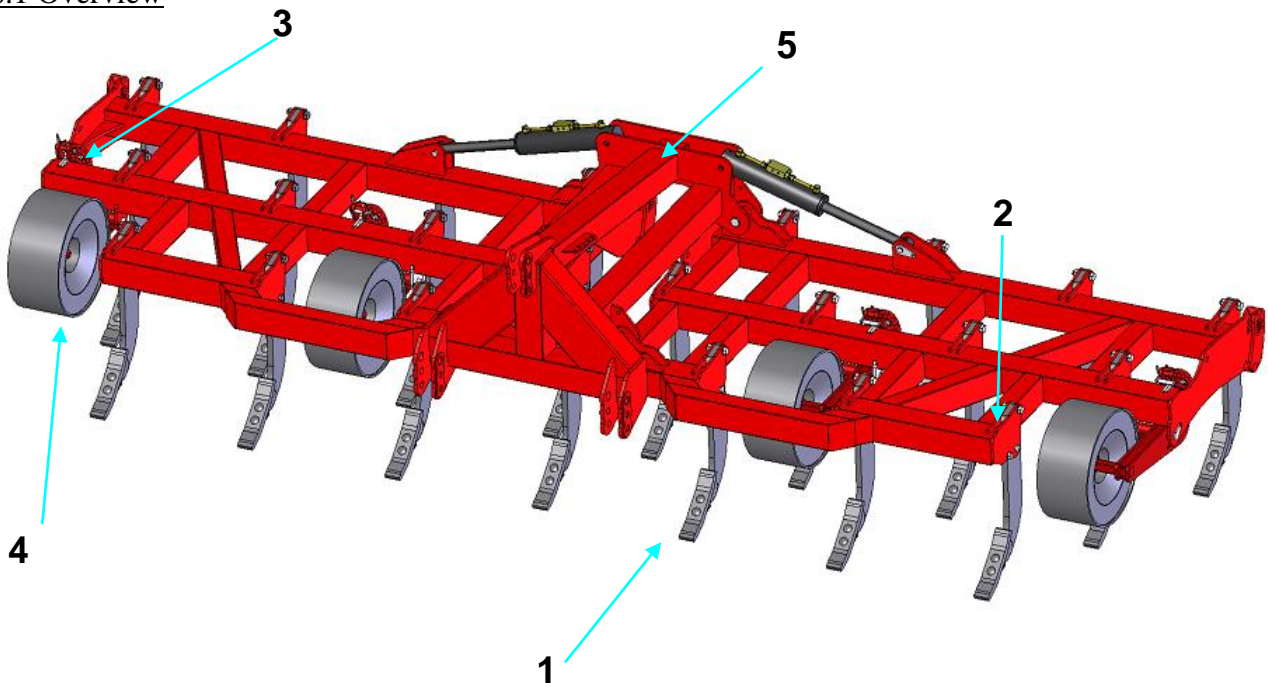

Item	Description	Page
1	Point Assembly	9
2	Leg & Shear bolt Assembly	10
3	Depth Control	11
4	Wheel Assembly	12
5	Main Frame	13

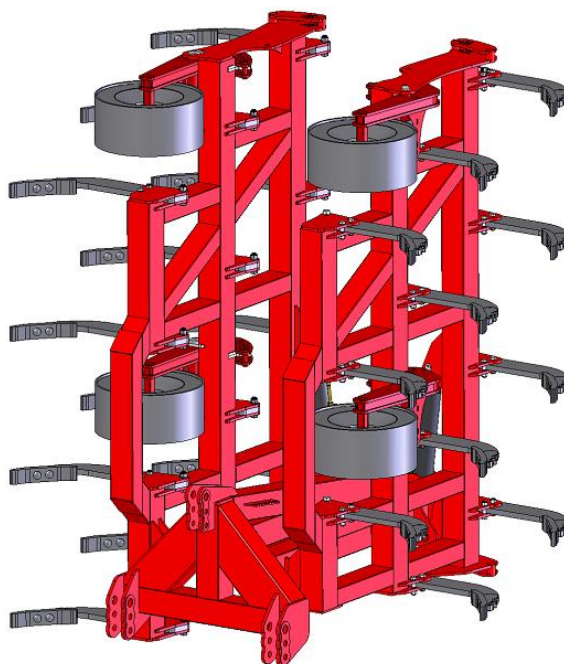

6.2 Point Assembly

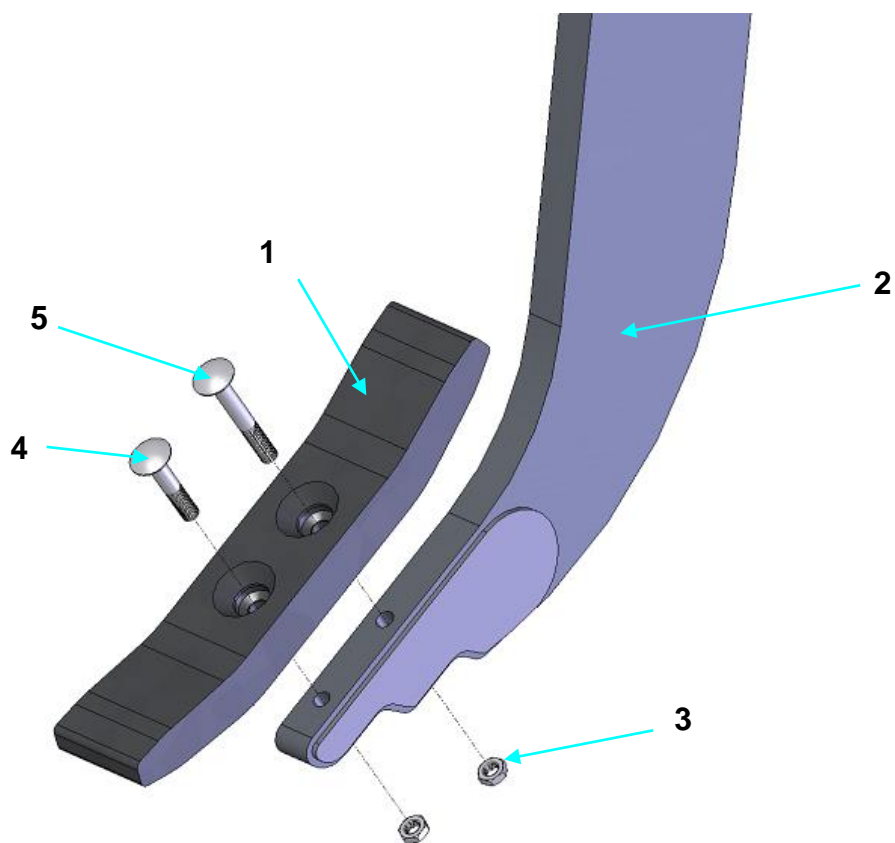

Item	Part No.	Description	Quantity/4 m machine	Quantity/5 m machine	Quantity/6 m machine	Quantity/7 m machine
1	SW195	Rippa Point	15	19	23	27
2	SW271	Rippa leg	15	19	23	27
3	SWM12003	M12 plain nut	30	38	46	54
4	SWM1265PB	M12x65 plough bolt short	15	19	23	27
5	SWM1290PB	M12x90 plough bolt long	15	19	23	27

6.3 Leg and Shear Bolt Assembly

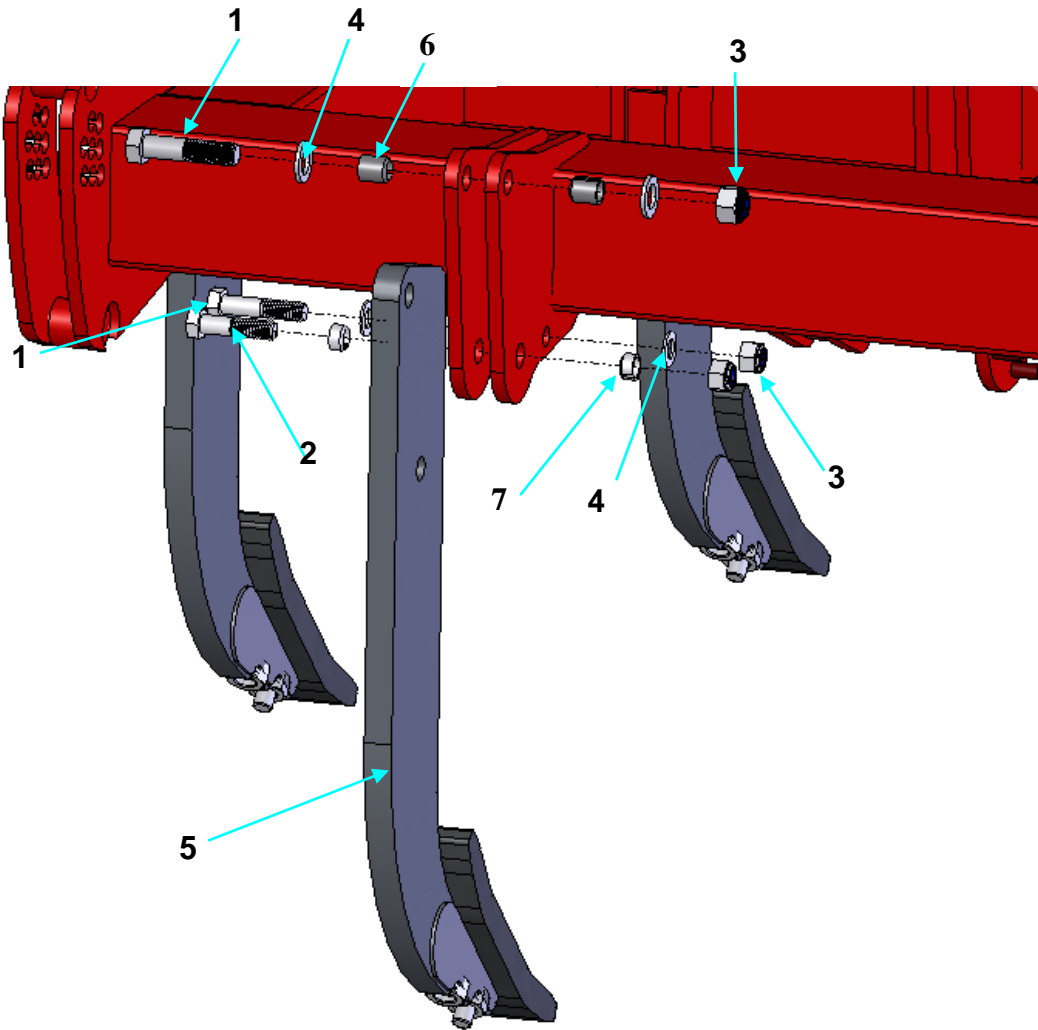

Item	Part No.	Description	Quantity/4m machine	Quantity/5m machine	Quantity/6m machine	Quantity/7m machine
1	SWM20100	M20 x 100 bolt	30	38	46	54
2	SWM2090SB	Rippa Shear Bolt	15	19	23	27
3	SWM20004	M20 nylock nut	45	57	69	81
4	SWM20001	M20 flat washer	60	76	92	108
5	SW271	Rippa leg	15	19	23	27
6	SW791	30mm Spring tension bush	30	38	46	54
7	SW790	15mm Spring tension bush	30	38	46	54

6.4 Depth Control

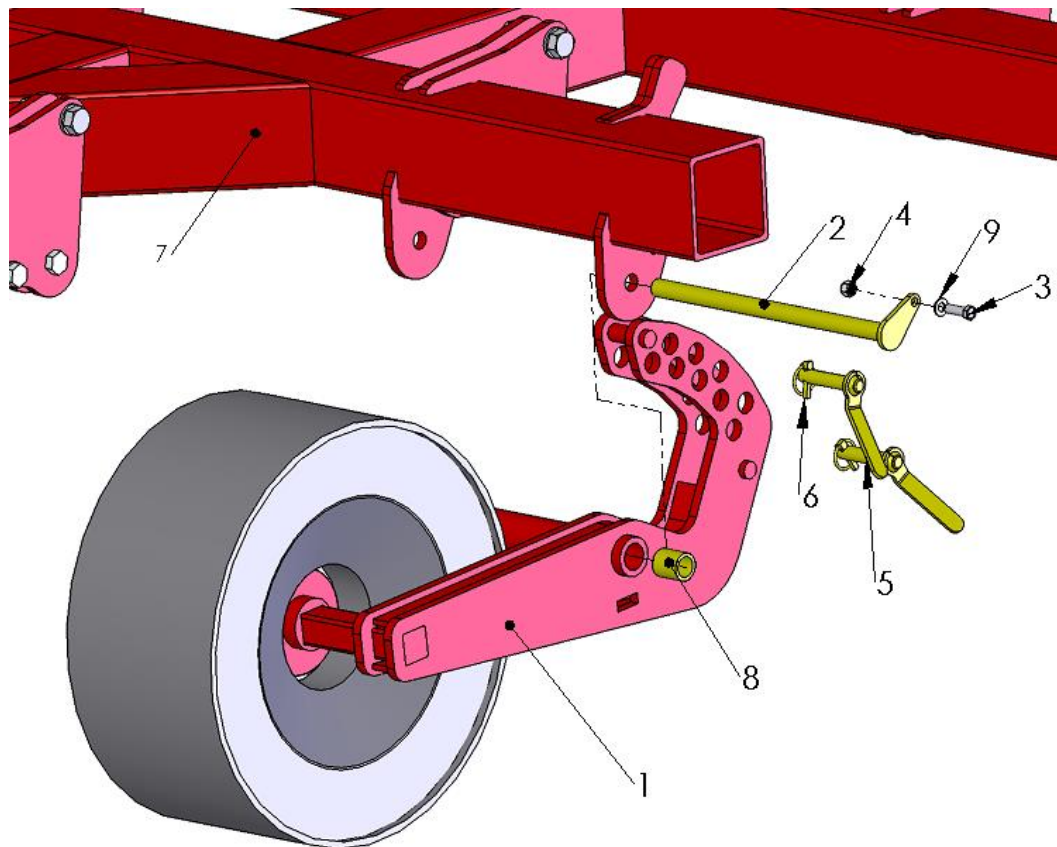

Item	Part No.	Description	Quantity/4m machine	Quantity/5m machine	Quantity/6m machine	Quantity/7m machine
1	SW274	Rippa wheel depth frame	2	2	4	4
2	SW275	Rippa wheel long pivot pin	2	2	4	4
3	SWM1240	M12x40 bolt	2	2	4	4
4	SWM12003	M12 plain nut	2	2	4	4
5	SW276	Rippa depth pin	4	4	8	8
6	SWB105	Linch Pin	4	4	8	8
8	SWB176	30x40x45 oilite bush	4	4	8	8
9	SWM12001	M12 flat washers	4	4	8	8

6.5 Wheel Assembly

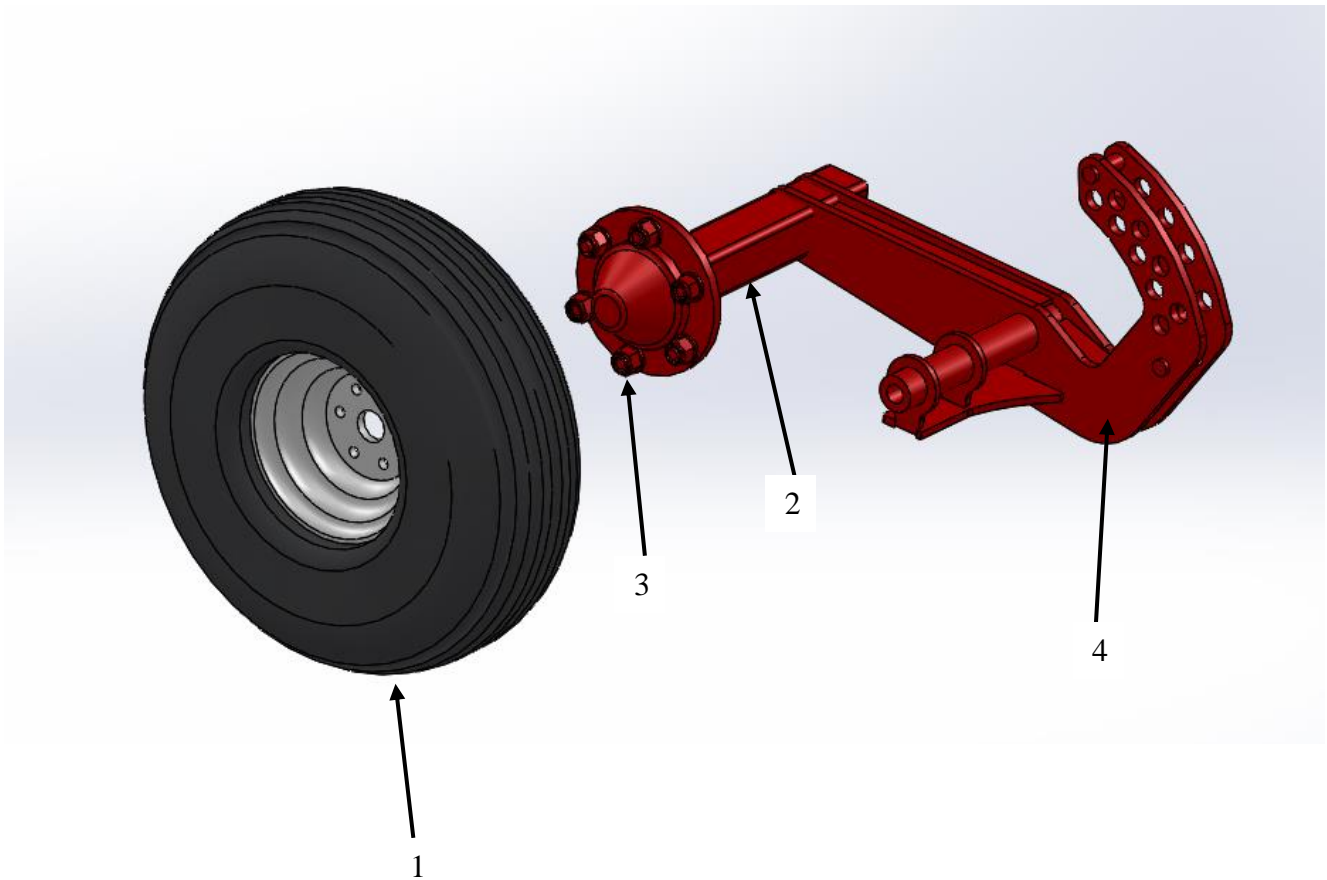



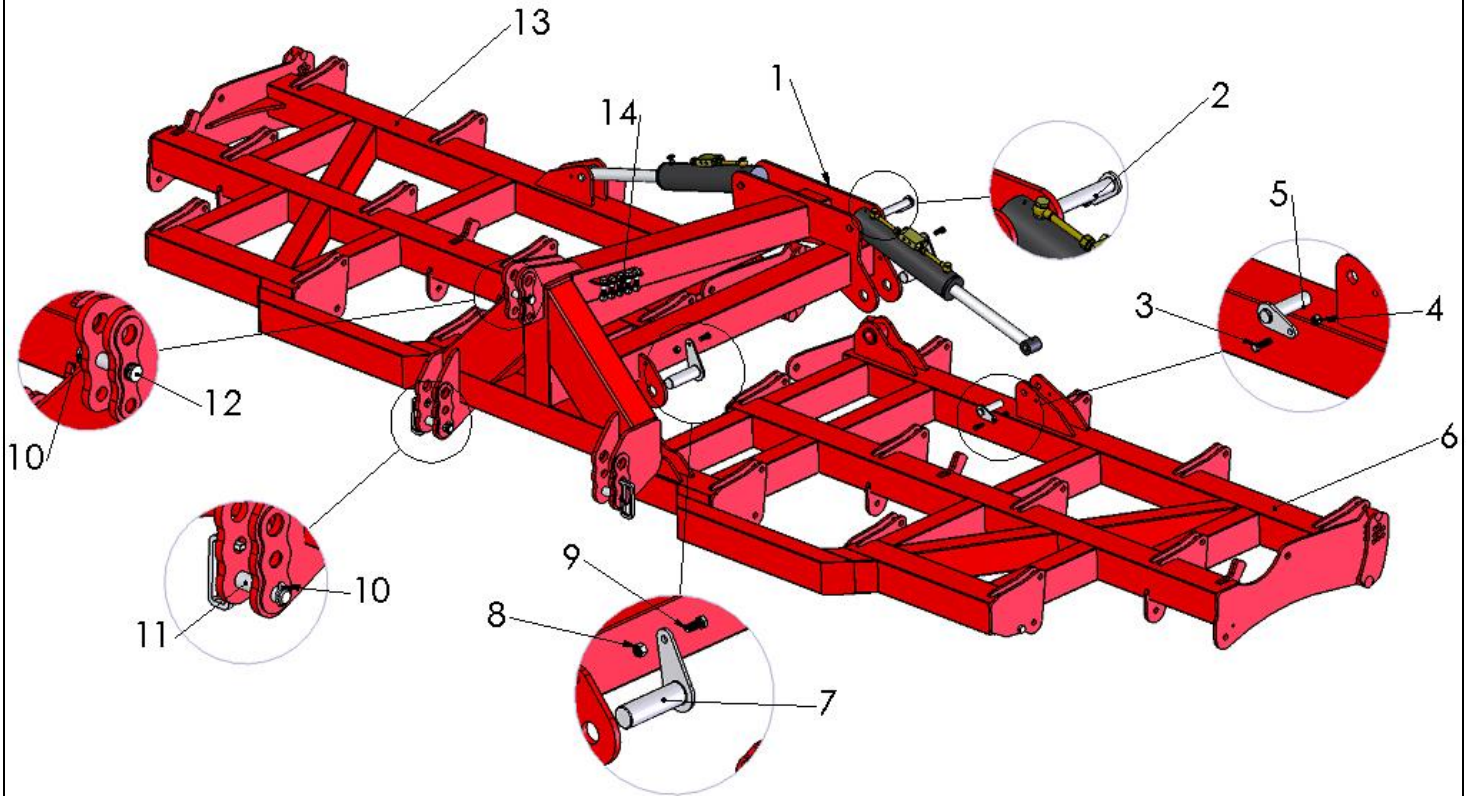

Item	Part No.	Description	Quantity/4m Machine	Quantity/5m Machine	Quantity/6 m machine	Quantity/7 m machine
1	SWB639	Rippa 6 stud Depth Wheel	2	2	4	4
2	SWB258	Rippa 6 stud hub unbraked complete	2	2	4	4
3	SWB153	Rippa wheel studs	12	12	24	24
4	SW585	Ripper RH steel depth wheel arm (not Shown)	1	1	2	2
	SW586	Ripper LH steel depth wheel arm	1	1	2	2

6.6 Main Frame



Item	Part No.	Description	Quantity/4m machine	Quantity/5m machine	Quantity/6m machine	Quantity/7m machine
1	SW285	Rippa Headstock	1	1	1	1
2	SW283	30 x 165 tabbed pin	2	2	2	2
3	SWM1245	M12x45 bolt	4	4	4	4
4	SWM12004	M12 nylock nut	4	4	4	4
5	SW286	30 x 112 tabbed pin	4	4	4	4
6	SW279	4m Rippa right wing	1	N/A	N/A	N/A
	SW280	5m Rippa right wing	N/A	1	N/A	N/A
	SW281	6m Rippa right wing	N/A	N/A	1	N/A
	SW282	7m Rippa right wing	N/A	N/A	N/A	1
7	SW284	50 x 165 tabbed pin	4	4	4	4
8	SWM1650	M16x50 bolt	4	4	4	4
9	SWM16004	M16 nylock nut	4	4	4	4
10	SWB107	Cat III safety linch pin (optional Cat IV)	3	3	3	3
11	SW132	Cat III lower link pin (optional Cat IV)	2	2	2	2
12	SW133	Cat III top link pin (optional Cat IV)	1	1	1	1
13	SW287	4m Rippa left wing	1	N/A	N/A	N/A
	SW288	5m Rippa left wing	N/A	1	N/A	N/A
	SW289	6m Rippa left wing	N/A	N/A	1	N/A
	SW290	7m Rippa left wing	N/A	N/A	N/A	1
14	SWM2090SB	Spare Rippa Shear Bolts	10	10	10	10

6.7 Stickers and Paint

Sticker	Description	Quantity	Part No.
	Big Sumo horizontal sticker 450 x 125mm	7	SWB125
	Rippa Sticker	5	SWB154
	Big Union Jack sticker 150 x 100mm	2	SWB127
	Vertical Sumo sticker 80 x 295mm	2	SWB128
	Small Union Jack sticker 70 x 50mm	2	SWB129
Touch up paint	Sumo Red	1/2 litre	SWB131
	Sumo Black	1/2 litre	SWB132

7.0 Hydraulics

7.1 Wings open/close circuit

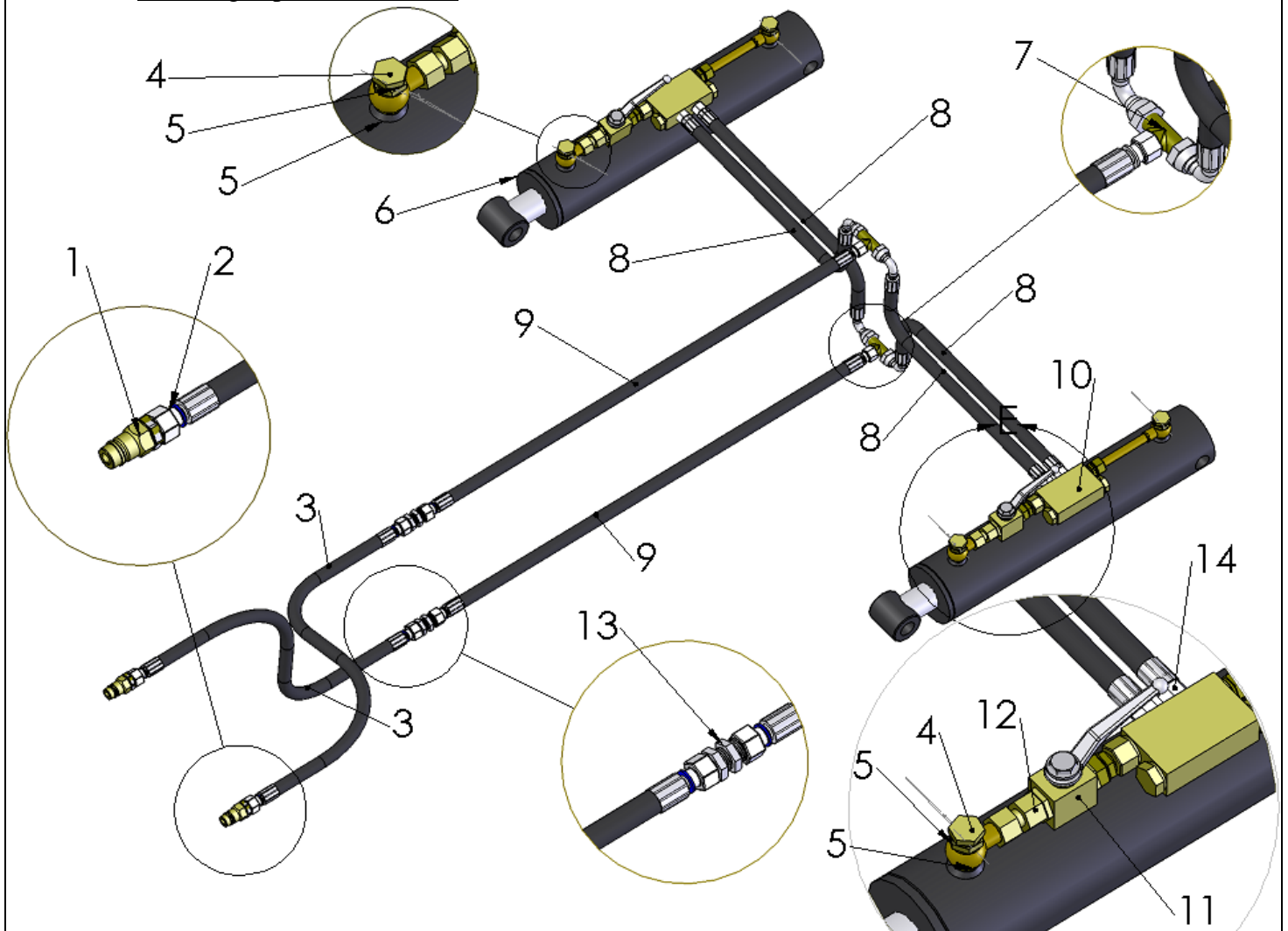

Item	Part No.	Description	Quantity
1	SWH147	Male quick coupler	2
2	SWH142	1/2" dowty washer	2
3	SWH202	1/2" Hyd hose bulk head to quick coupler	2
4	SWH143	1/2" banjo bolt	4
5	SWH142	1/2" dowty washer	8
6	SWH132	706/4 ram	2
7	SWH156	12L Tee branch	2
8	SWH203	3/8" Hyd hose tee to ram ports	4
9	SWH204	1/2" Hyd hose bulk head to tee	2
10	SWH154	Pilot operated check valve	2
11	SWH205	12L tap	2
12	SWH176	12L female to female fitting	2
13	SWH144	15L bulk head fitting	2
14	SWH171	12L - 3/8" M fitting	4